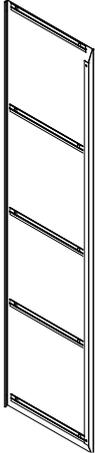
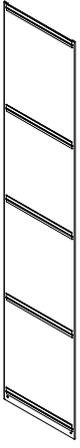
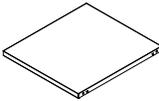
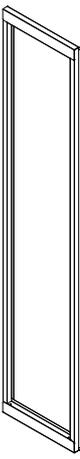
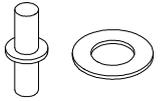
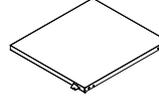
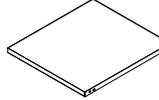
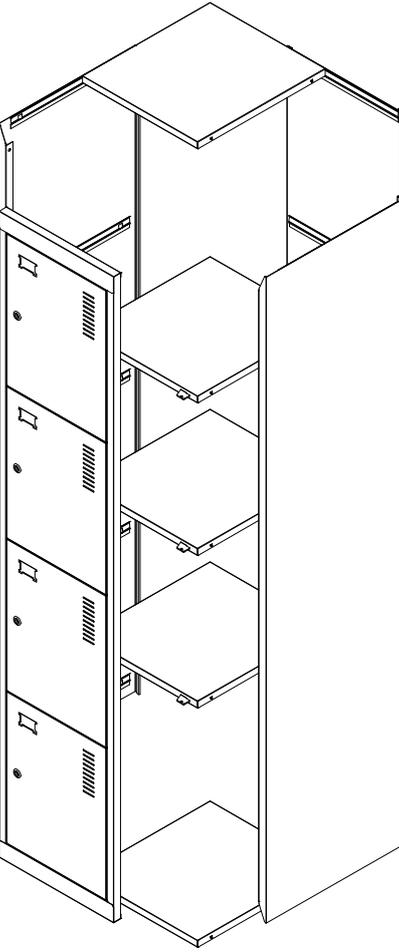
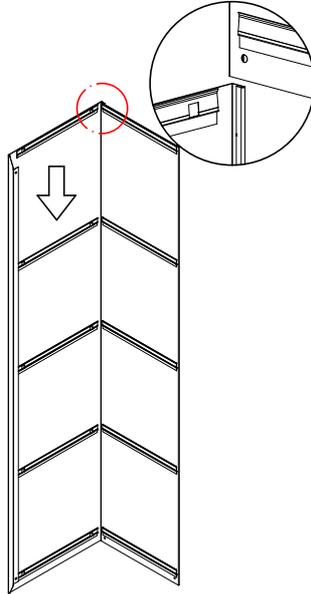
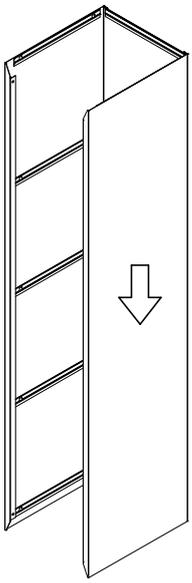
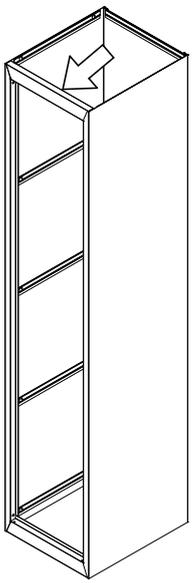
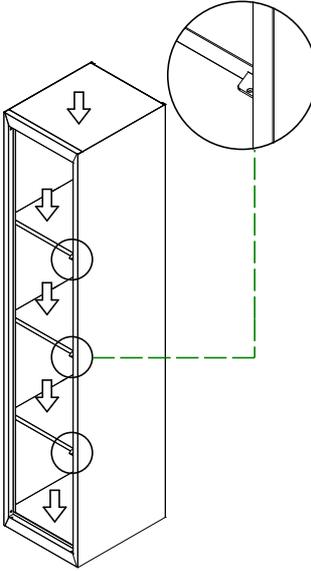
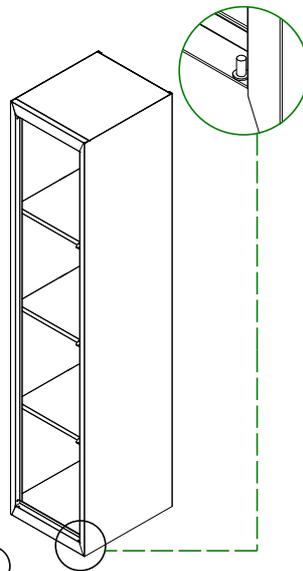
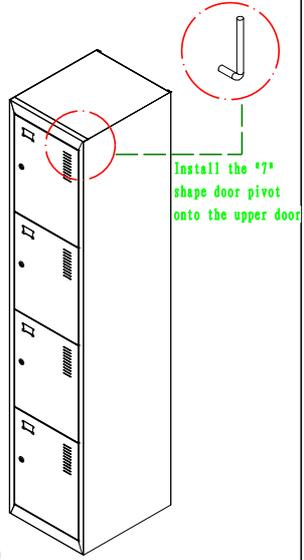

# Installation:

						
Side Plate(left): 1Pc	Side Plate(Right): 1Pc	Back Plate: 1Pc	Top Plate: 1Pc	Door Frame: 1 Pc	Door: 4Pcs	Short Pivot: 5Pcs Pivot washer: 8Pcs
						
			Middle Plate: 3Pcs		*7*Shape Door Pivot: 2Pcs	Key: 4Pcs
						
			Bottom Plate: 1Pc			

			
	1 Cuttage grafting the side plate and back plate	2 Cuttage grafting the other side plate and back plate in the same way.	3 Fix the door frame as the sign.
			
	4 Install the top, middle and bottom plate	5 Put the short door pivot at the bottom and then install the first door.	6 Install the other door in the same way, then adjust each part till fit well after installation.