

Installation:

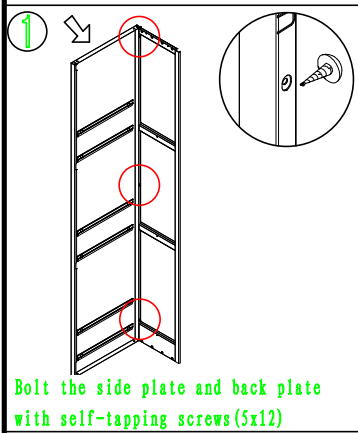

1 Bolt the side plate and back plate with self-tapping screws (5x12)

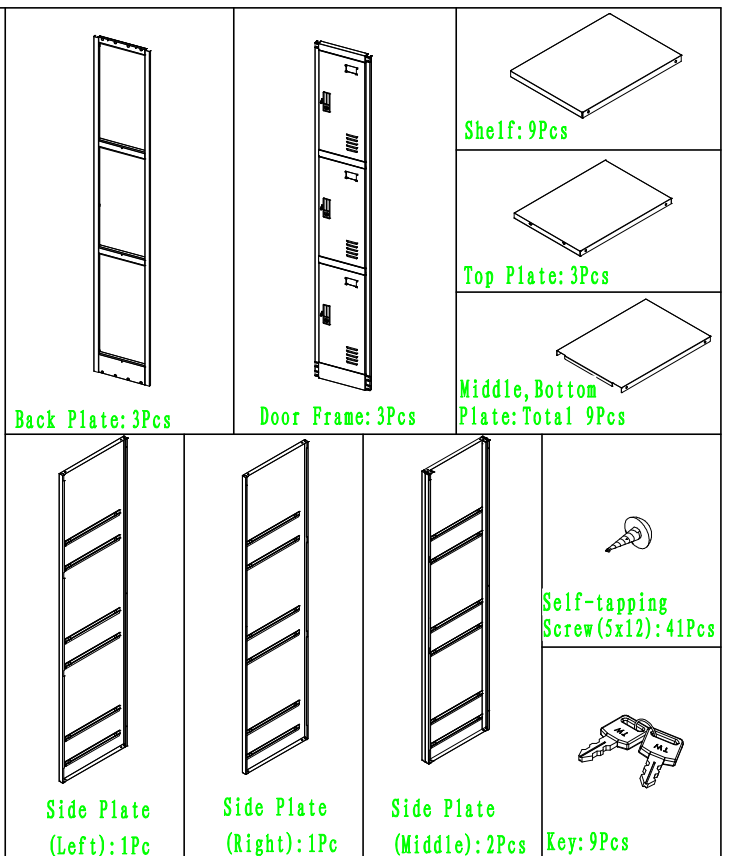
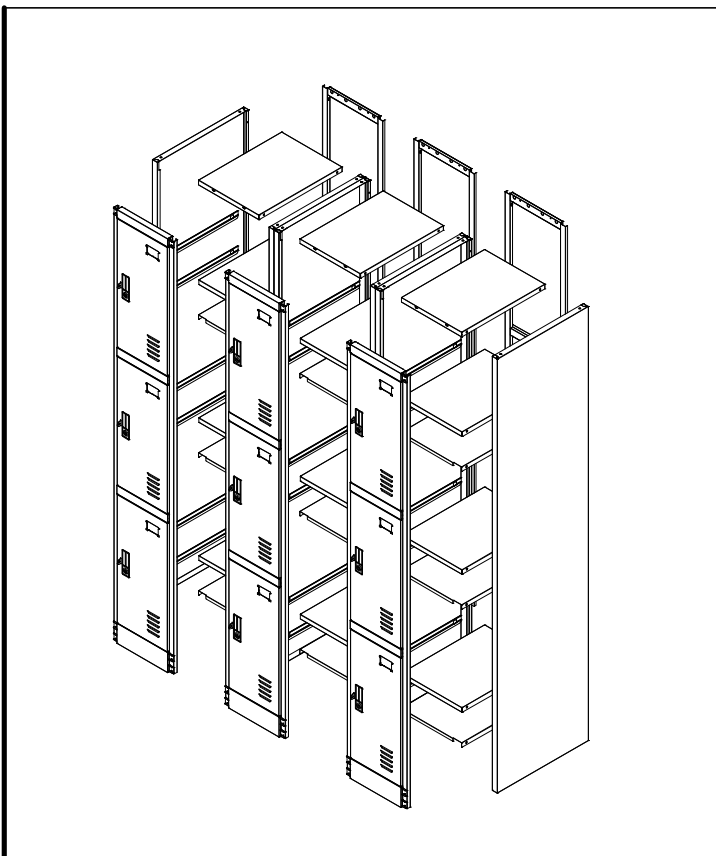
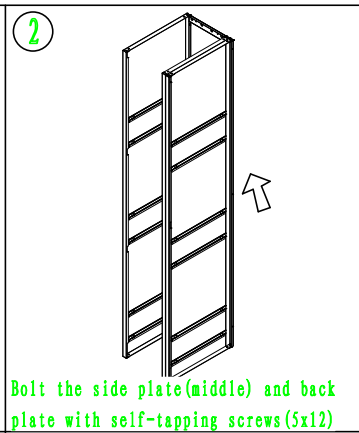

2 Bolt the side plate (middle) and back plate with self-tapping screws (5x12)

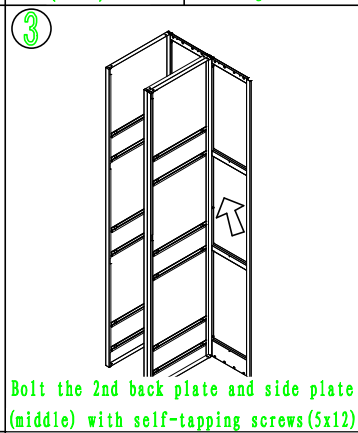

3 Bolt the 2nd back plate and side plate (middle) with self-tapping screws (5x12)

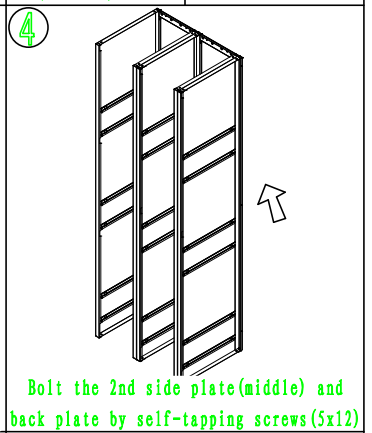

4 Bolt the 2nd side plate (middle) and back plate by self-tapping screws (5x12)

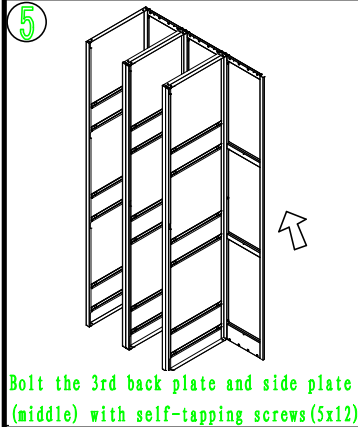

5 Bolt the 3rd back plate and side plate (middle) with self-tapping screws (5x12)

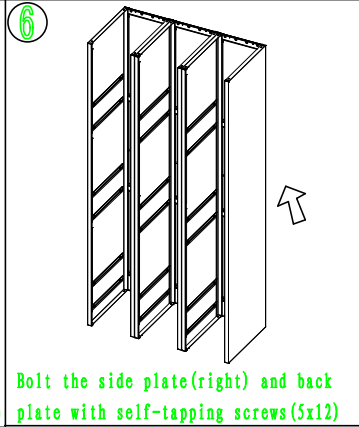

6 Bolt the side plate (right) and back plate with self-tapping screws (5x12)

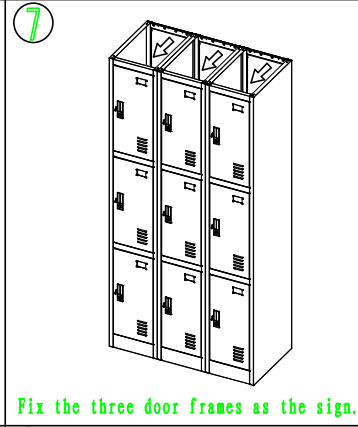

7 Fix the three door frames as the sign.

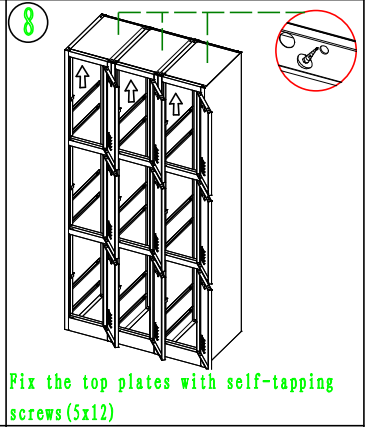

8 Fix the top plates with self-tapping screws (5x12)

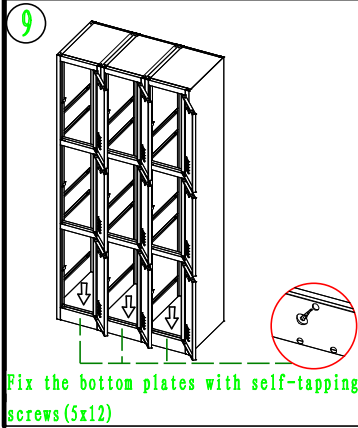

9 Fix the bottom plates with self-tapping screws (5x12)

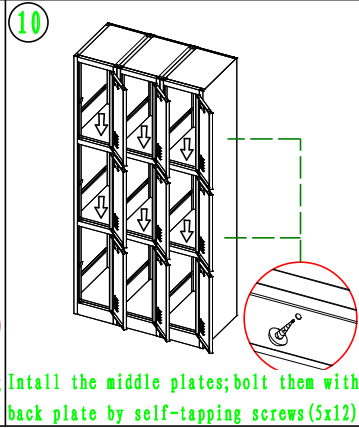

10 Install the middle plates; bolt them with back plate by self-tapping screws (5x12)

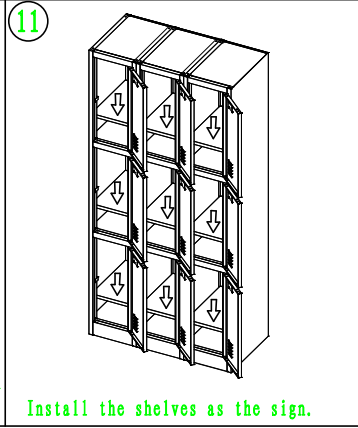

11 Install the shelves as the sign.

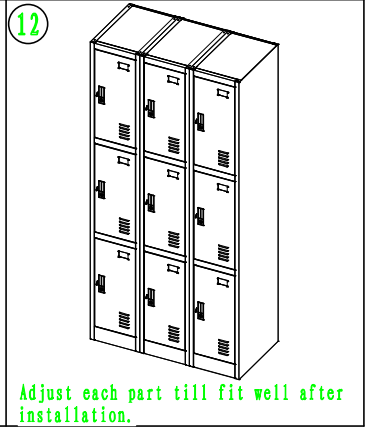

12 Adjust each part till fit well after installation.