

Side Plate(left):1pc

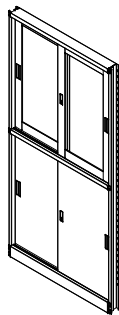

Side Plate(Right):1pc



Door Frame:1pc

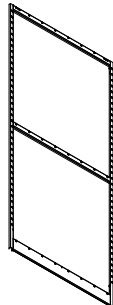

Back Plate:1Pc

Top Plate:1Pc

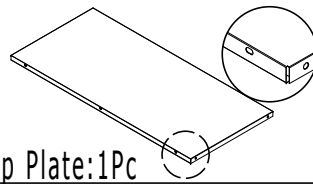

Middle Plate:1Pc
Bottom Plate:1Pc

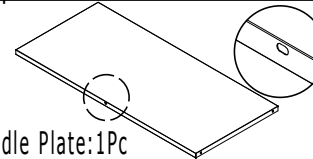

Shelf:2Pc

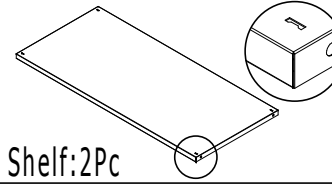

Shelf Holder:8pcs

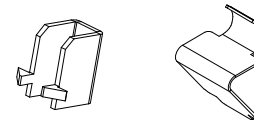

Self-tapping
Screw(5x12):16Pcs



Key:2 Set



install the handle:
fit the bottom part first

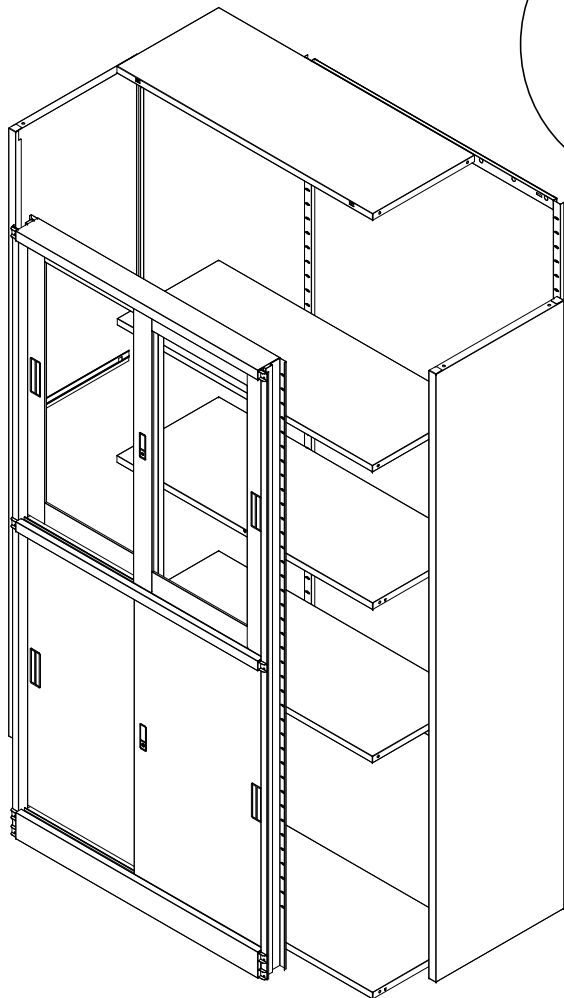
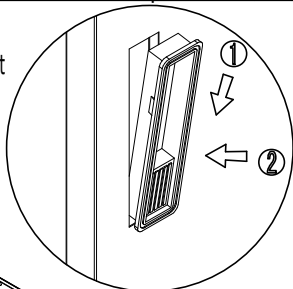

①

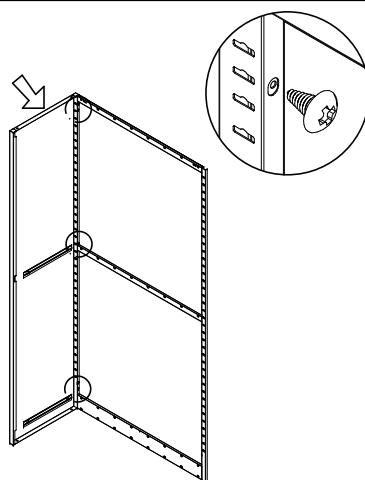

Bolt the left side and back
plate with self-tapping screws(5x12)

②

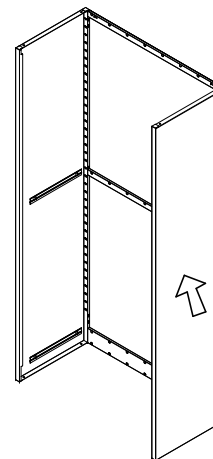

Bolt the right plate and back plate in
the same way as the first step

③

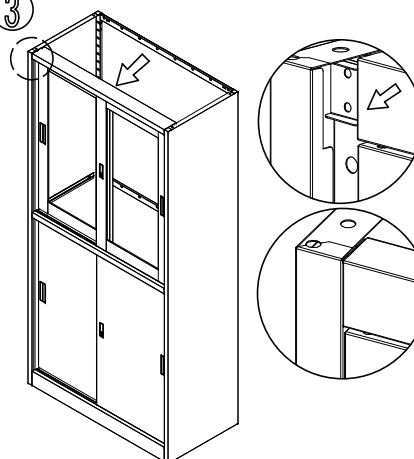

Fix the door frame onto both of
the side plates

④

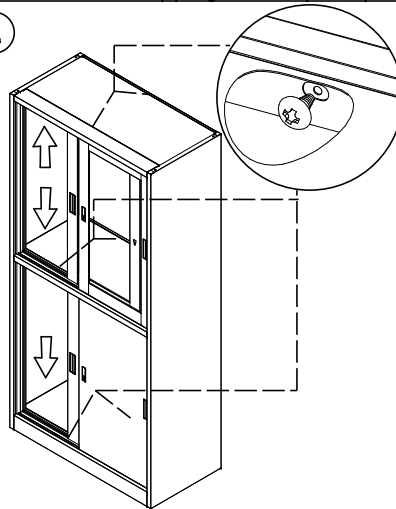
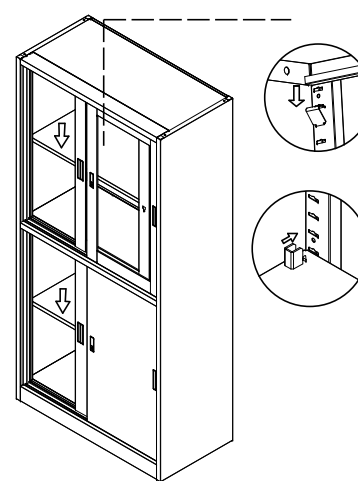

plate respectively

⑤



Install the shelves.

⑥

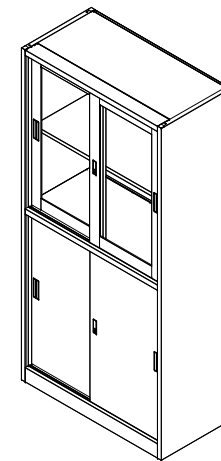

Adjust each parts till
fit well after installation