

Self-tapping  
Screw(5x12):5Pcs



Left Side:1Pc

Right Side:1Pc

Door Frame:1Pc

Back Plate:1Pc

Bottom plate:1pc

Top Plate:1Pc

Shelf:2Pc

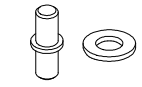
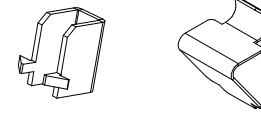

Shelf Holder:8pcs

Key:1 Set

Door Pivot: 2Pcs

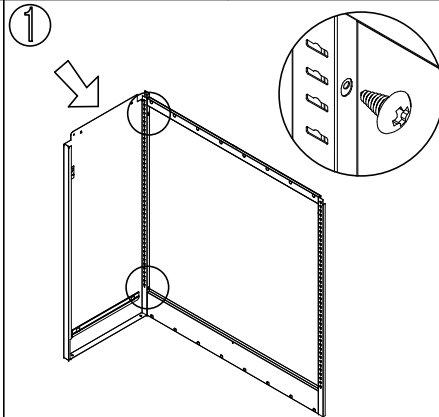
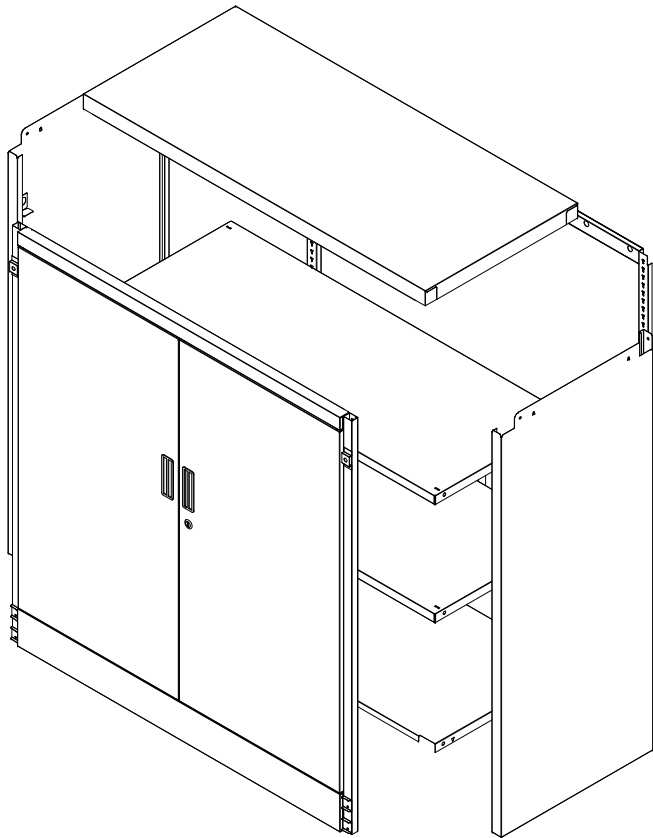

1 Bolt the left side and back plate with self-tapping screws(5x12)

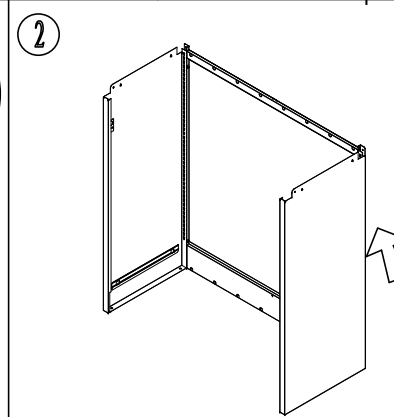

2 Bolt the right plate and back plate in the same way as the first step

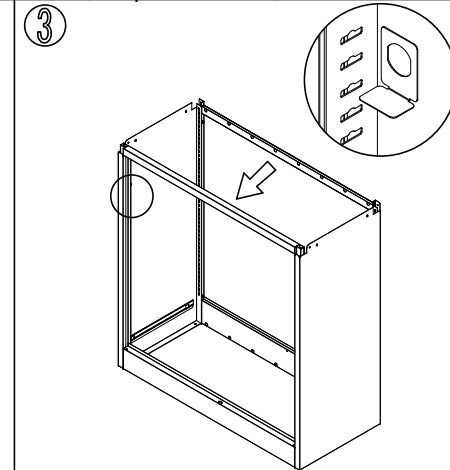

3 Fix the door frame onto both of the side plates

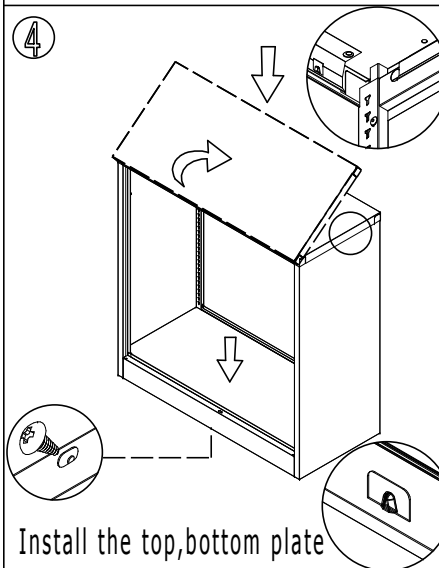

4 Install the top, bottom plate

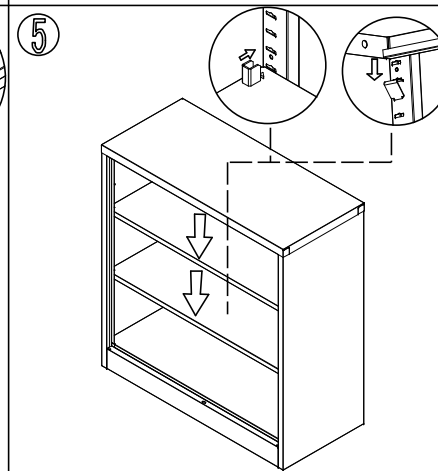

5 Install the shelves.

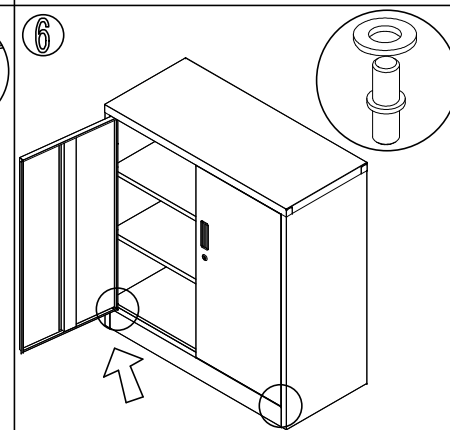

6 Install the doors as the sign, Adjust each parts till fit well after installation