

Top Plate:1Pc

Front Panel:3Pcs

Front Drawer Seal:3Pcs

Back Drawer Seal:3Pcs

Front Base:1Pc

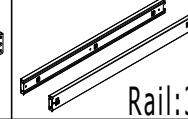
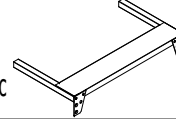

Rail:3Sets

Back Base:1Pc

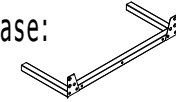

Hanging Rod:3Pcs



Key:1Set

M5x12 Self-tapping Screw:6Pcs



M6x12 Screw:8Sets

Left Side:1Pc

Right Side:1Pc

Back Plate:1Pc

Lock Rod:1Pc

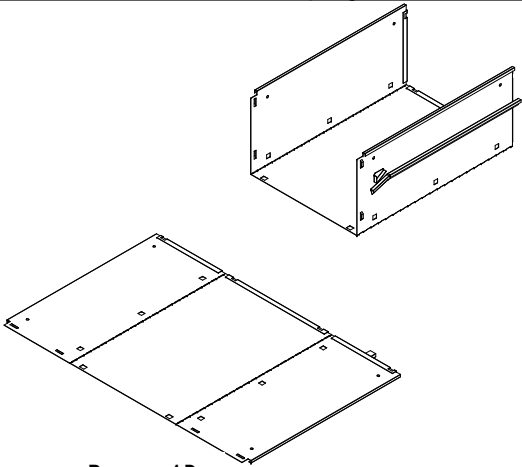

Drawer Box: 4Pcs

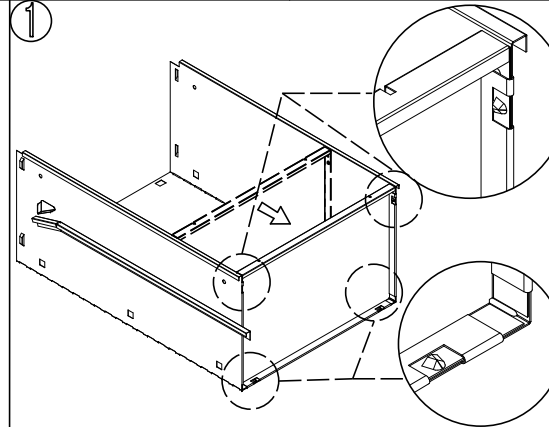
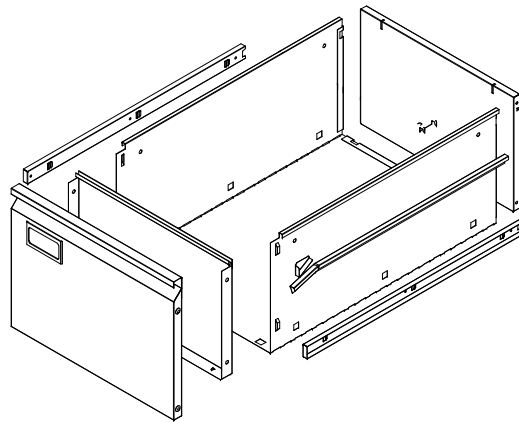

Push the back seal to the end.

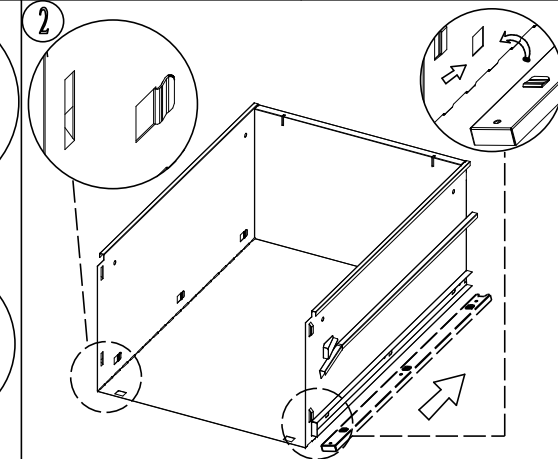

Install the inner rails.

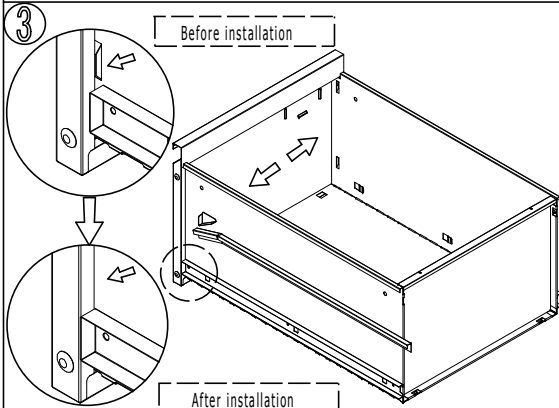

Install the front panel.

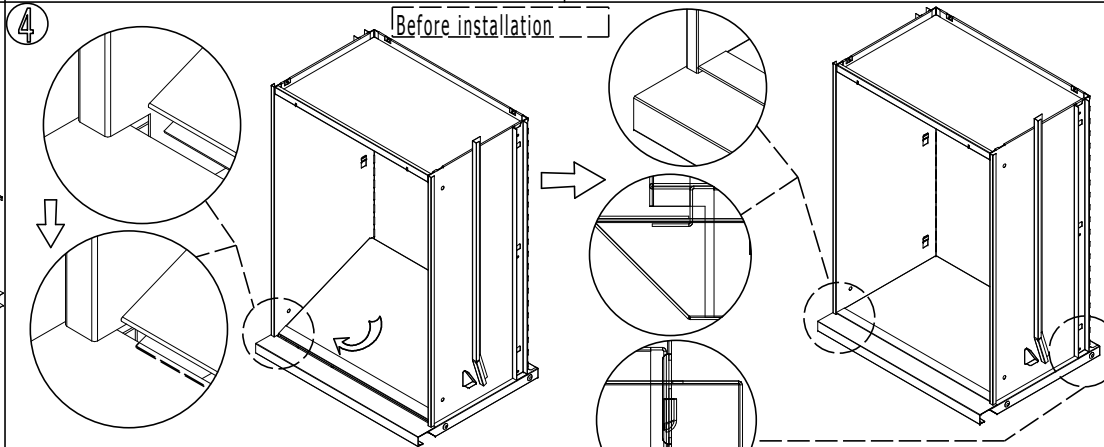

Install the front drawer seal.

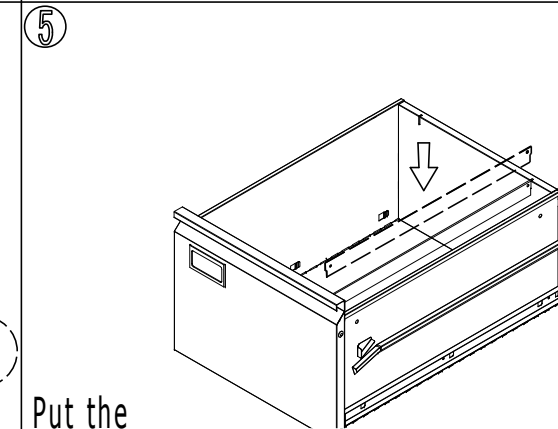

Put the hanging rods onto the drawers.